

PACK

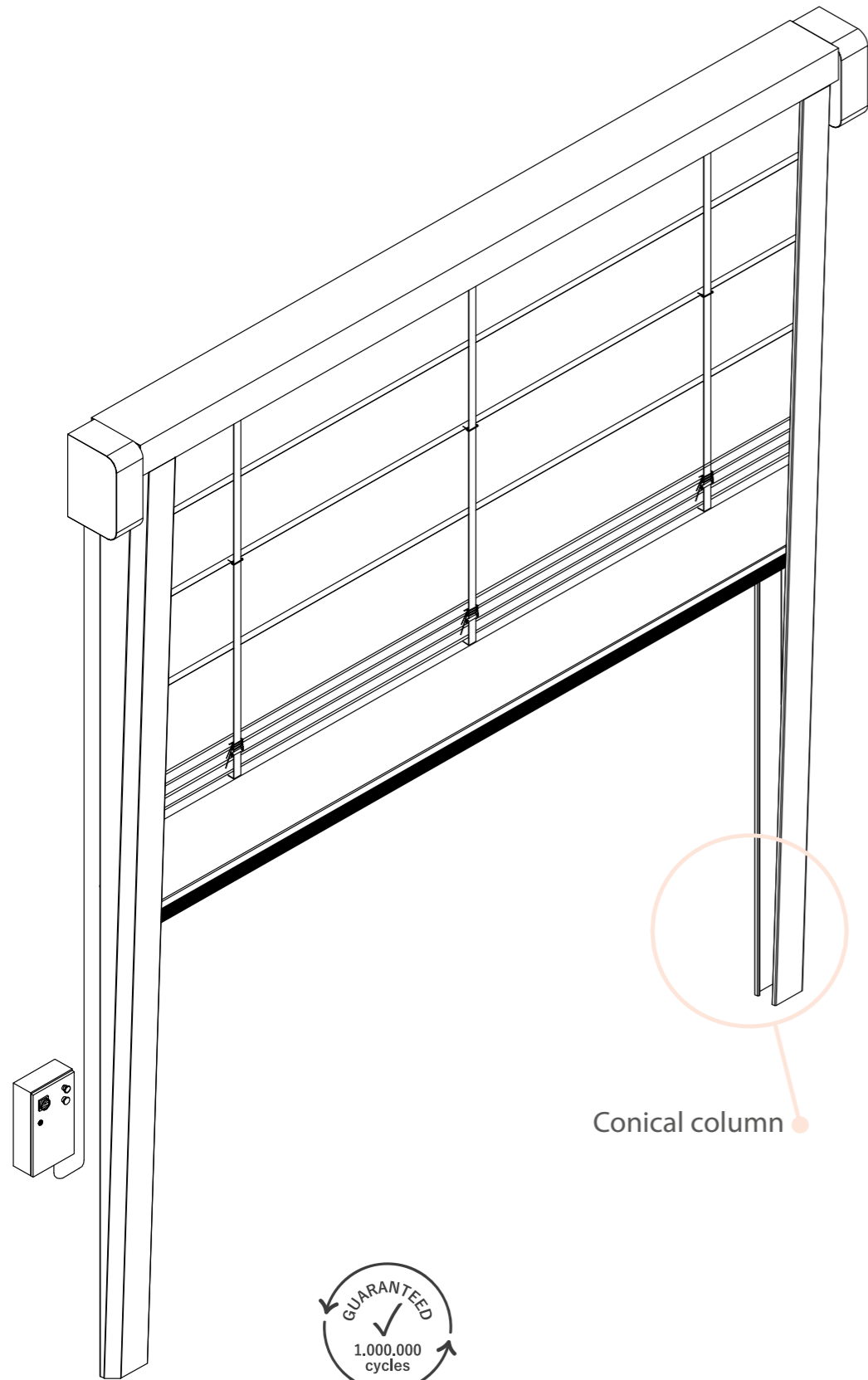

Conical column

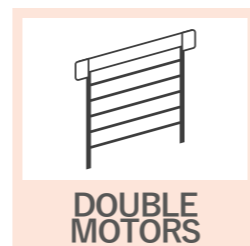
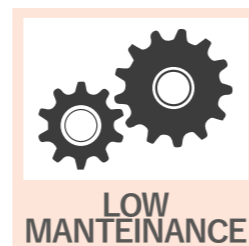

DESCRIPTION

PACK door is a fold up door composed by perimeter self-supporting frame in galvanized steel and a PVC curtain. Reinforced with horizontal steel bars to assure a wind resistance up to 160 Km/h. Curtain is lifted by strong belts and collected on top.

The patent conical guides give to the **PACK** a low air permeability and a good performance in case of high wind load. Studied for heavy industry too is suitable for all kind of industries. Perfect for internal and external applications, for big openings and designed for a long life.

PACK is the right solution in case of strong wind and depressions.

ADVANTAGES

- ✓ Wind resistance up to 160 km/h
- ✓ Working in depression/ pressure up to 120 km/h
- ✓ Basic automation

APPLICATION

Fold up door with conical columns and double motors ideal for:

- ✓ Waste treatment
- ✓ Airport
- ✓ Industry
- ✓ Heavy industry
- ✓ Crane door
- ✓ Chemical
- ✓ Shipyard
- ✓ Agriculture

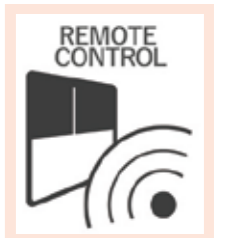
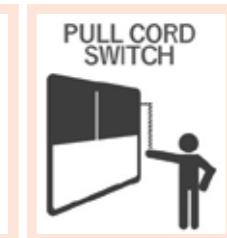
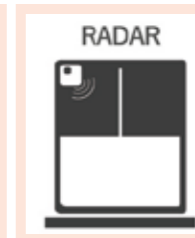

EN13241/CF

Standard	Rif.	Test acc.	Results
Water permeability	EN 12425	EN 12489	Class 1
Wind load	EN 12424	EN 12444	Class 4
Wind permeability	EN 12426	EN 12427	Class 0
Safe openings	EN 12453	EN 12445	✓
Mechanical resistance	EN 12604	EN 12605	✓
Unintended movements	EN 12604	EN 12605	✓
Thermal transmittance	EN 12428	EN 12428	6,02 W/m ² K
Performance (cycles)	EN 12604	EN 12605	1.000.000

VALUES CAN CHANGE DEPENDING ON DOOR DIMENSIONS

FEATURES	
Maximum dimensions	W 20.000 mm x H 15.000 mm
Speed	Max opening speed up to 1 m/s
	Closing speed 1 m/s
Wind resistance	Standard Class 2 up to 35 m ² further on project till Class 4
Structure	Self-supporting
Frame / motor cover hood	Standard: Galvanized Steel
	Optional: Powder coated Steel Stainless Steel 441/304/316
Curtain	Standard: PVC curtain fabric 900 gr/m ²
	Optional: Insulated 3 mm Insulated 7 mm Translucent 35/40% FDA (white) Antistatic
	Standard: Powder coated Steel box IP54 (300 x 500 x 150 mm)
	Optional: Stainless Steel PVC box IP65 (300 x 400 x 150 mm)
	Control panel
Control panel	Contactors
	Thermail modular protection
	Power supply 3-ph, 3-230V
	Power supply 3-ph, 3-400V
	Start/Stop Button
	Emergency stop button
	IP rating for motor and control panel IP54
Safety	Standard: Photocells set IP65 WiFi safety edge IP65
	Optional: Multi ray light curtain barrier H2500 IP67
Emergency opening	Standard: Hand crank
	Optional: Counterweight system Chain system

FEATURES	
Advising operative temperature	Operating till - 30 C° + 70° C - Not apt to be installed in negative/positive temperature
Cycles (EN 12604)	1.000.000 (tested)

COAT STIFFENING / LIFTING SYSTEM

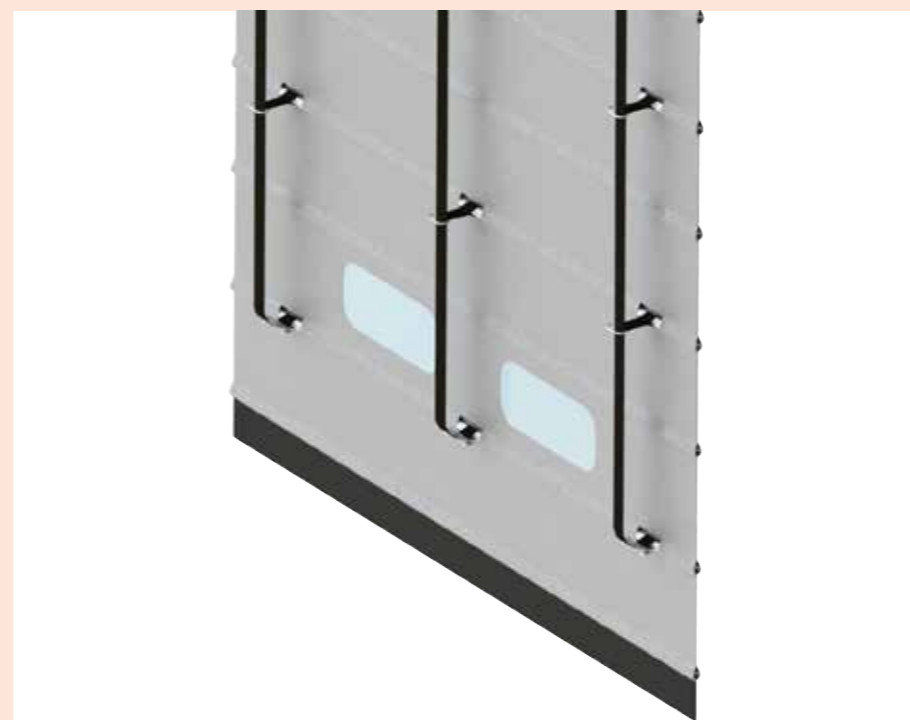

DOOR SPACE REQUIREMENTS

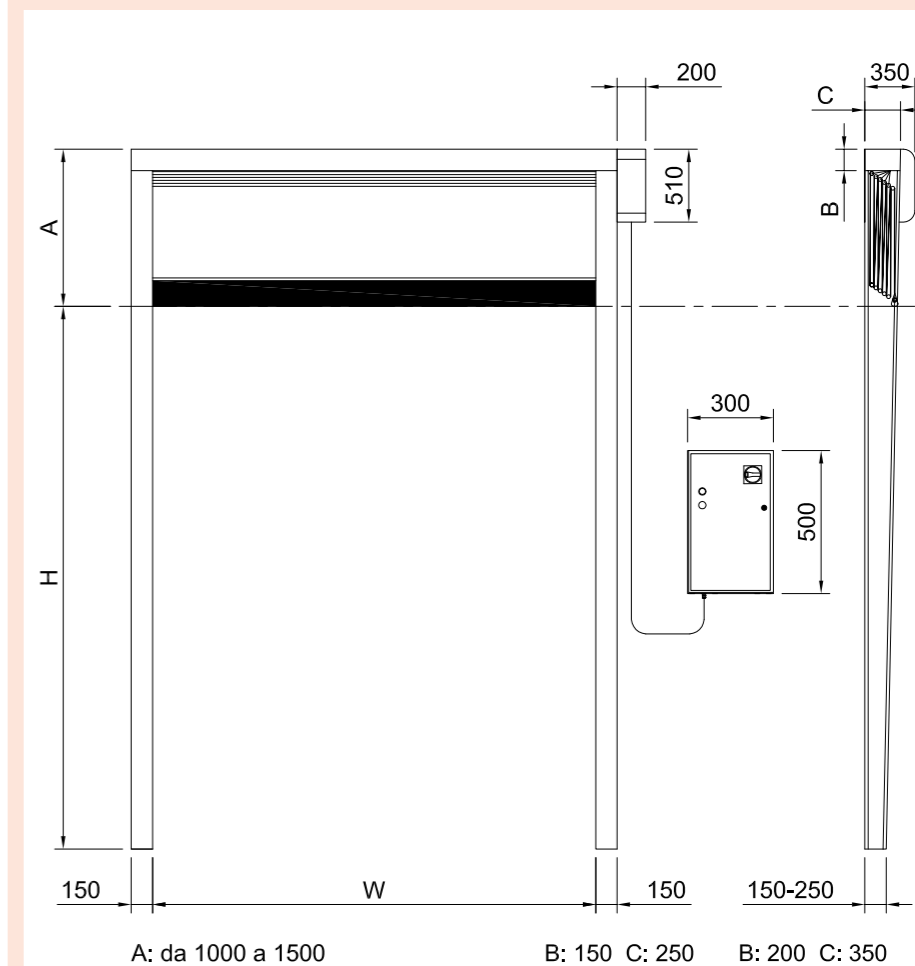

SEALING SYSTEM

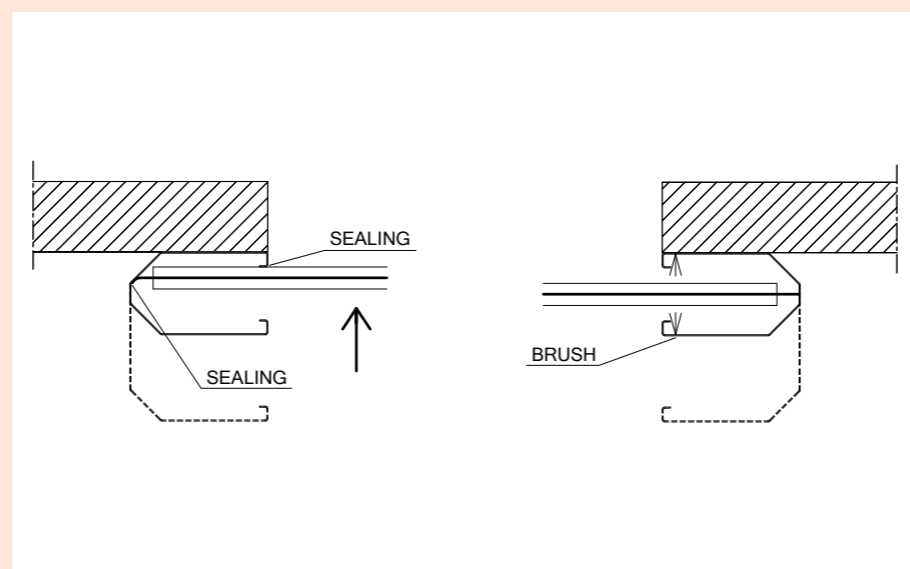

FIXING DETAILS

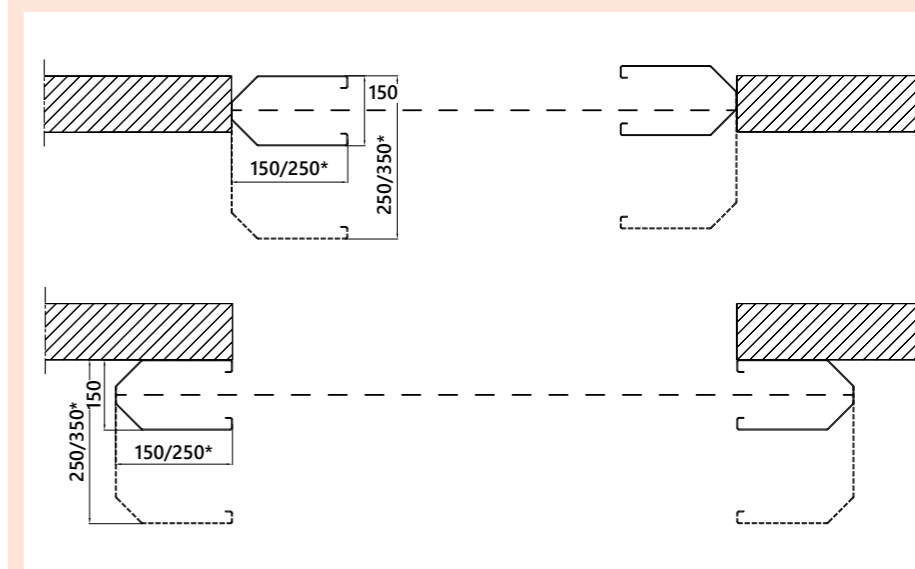

AVAILABLE COLOURS

Simil RAL 9010

Simil RAL 1015	Simil RAL 3002	Simil RAL 9006	Simil RAL 7035	Simil RAL 5010
Simil RAL 1003	Simil RAL 8014	Simil RAL 7042	Simil RAL 6018	Simil RAL 5002
Simil RAL 2004	Simil RAL 9005	Simil RAL 7037	Simil RAL 6026	Simil RAL 5012

Technical data



PVC CURTAIN / TELO PVC 1,3 mm - 1300 gr/m²

Simil RAL 9010 <input type="checkbox"/>	Simil RAL 2004 <input type="checkbox"/>	Simil RAL 7042 <input type="checkbox"/>	Simil RAL 5012 <input type="checkbox"/>
Simil RAL 1015 <input type="checkbox"/>	Simil RAL 3002 <input type="checkbox"/>	Simil RAL 7037 <input type="checkbox"/>	Simil RAL 5002 <input type="checkbox"/>
Simil RAL 1003 <input type="checkbox"/>	Simil RAL 6026 <input type="checkbox"/>	Simil RAL 7035 <input type="checkbox"/>	

Simil RAL 9010 <input type="checkbox"/>	Simil RAL 3002 <input type="checkbox"/>	Simil RAL 7035 <input type="checkbox"/>	Simil RAL 9005 <input type="checkbox"/>
Simil RAL 1015 <input type="checkbox"/>	Simil RAL 8014 <input type="checkbox"/>	Simil RAL 7037 <input type="checkbox"/>	Simil RAL 5010 <input type="checkbox"/>
Simil RAL 1003 <input type="checkbox"/>	Simil RAL 6026 <input type="checkbox"/>	Simil RAL 7042 <input type="checkbox"/>	Simil RAL 5002 <input type="checkbox"/>
Simil RAL 2004 <input type="checkbox"/>	Simil RAL 6018 <input type="checkbox"/>	Simil RAL 9006 <input type="checkbox"/>	Simil RAL 5012 <input type="checkbox"/>

PVC CURTAIN / TELO PVC 0,9 mm - 900 gr/m²



INSULATED CURTAIN / TELO COIBENTATO 3,5 mm - 1300 gr/m²

Simil RAL 9010 <input type="checkbox"/>	Simil RAL 6026 <input type="checkbox"/>	Simil RAL 7035 <input type="checkbox"/>	Simil RAL 5002 <input type="checkbox"/>
---	---	---	---

Simil RAL 9010 <input type="checkbox"/>	Simil RAL 2004 <input type="checkbox"/>	Simil RAL 7035 <input type="checkbox"/>
Simil RAL 1003 <input type="checkbox"/>	Simil RAL 3002 <input type="checkbox"/>	Simil RAL 5002 <input type="checkbox"/>

INSULATED CURTAIN / TELO COIBENTATO 7 mm

Simil RAL 9010 <input type="checkbox"/>

FOOD CURTAIN (FDA) 1,7 mm - 1700 gr/m²

TYPE OF COATING AND FINISH / MATERIALE FINITURA TELO		
Coating material / Materiale	PVC	
Top coating / Finitura	Lacquered finishing on both sides / Laccato su entrambi i lati	
Flammability / Resistenza al fuoco	ISO 3795 < 100 mm/min.	
Best weight / Peso totale	900 / 1300 g/m ²	DIN EN ISO 2286-2
Tensile strength / Resistenza alla trazione	4300 / 4000 N/50 mm	DIN EN ISO 1421/V1
Tear strength / Resistenza alla lacerazione	500 / 500 N	DIN 53363
Adhesion / Adesione	20 N/cm	LB 3.04-1
Low temperature resistance / Resistenza al freddo	-40 °C	DIN EN 1876-1
High temperature resistance / Resistenza al caldo	+70 °C	LB 3.15
Color fastness to light / Solidità alla luce	>6 Value / Note	DIN EN ISO 105 B02
Bending strenght / Resistenza alle piegature	No creases / Nessuna piega	10.000 x @ DIN 53359 A

BASE FABRIC / TESSUTO DI SUPPORTO		
Material / Materiale	DIN ISO 2076	
Yarn count / Titolo del filato	1100 dtex	DIN ISO 2060
Weave / Armatura	P2/2	
Notes / Note	Complies with DIN EN 12641-2 / Soddisfa i requisiti DIN EN 12641-2	



FOLD UP DOORS

PACK[®] door is a fold up door composed by perimeter self-supporting frame in galvanized steel and a PVC curtain reinforced with horizontal steel bars.

The patent conical guides give to the **PACK[®]** a low air permeability. **PACK[®]** door is suitable for all kind of industries, for internal and external applications. It is designed for big openings and for a long life. It's the right solution in the case of strong wind and depressions.

La porta ad impacchettamento **PACK[®]** è dotata di una struttura perimetrale in acciaio zincato e un manto in pvc rinforzato con barre in acciaio orizzontali.

Dotata di una buona tenuta stagna grazie al sistema brevettato di guide coniche è progettata per usi gravosi, la **PACK[®]** è adatta a qualsiasi applicazione industriale. Ideale per applicazioni interne ed esterne è stata inoltre progettata per durare nel tempo e resistere a forti venti o depressioni.

PORTA AD IMPACCHETTAMENTO

TECHNICAL DATA / DATI TECNICI

Maximum door size (W x H) / Dimensioni massime (L x H)	20.000 x 15.000 mm	Opening speed / Velocità d'apertura	~ 1 m/sec.
		Closing speed / Velocità di chiusura	1 m/sec.
Wind load / Resistenza al vento:	Class 2 / Classe 2	Applications / Applicazioni	Inside and outside / Interno ed esterno

Up to 35 m² further on project till Class 4 / fino a 35 m² oltre a progetto fino a Classe 4 *

Pack[®]